

SMX 600 E mixer

Parts list

Code

Aluminium Fan	0509	
Carbon brushes (pair)	0529	
Ball bearing	0601	
Motor ball bearing	0602	
Rubber washer	0760	
Clips	0776	
Washer & bolt for fan	0777	
Wall bracket	0862	
Strain relief 230 V	0950	
Strain relief 115 V	0950.1	
ID label 230 V	1007	
ID label 115 V	1009	
Bearing holder + seal	1185	
Shaft & ball bearing	45120	
Coupling sleeves	45122	
Motor & shaft drive sprocket	45123	
Fan housing	45125	
Double isolation part	45126	
Lower ball bearing assembly	45130	
Lower motor casing	45132	
Upper motor casing	45133	
Stator 230 V	45135	
Stator 115 V	45135.1	
Rotor 230 V	45136	
Rotor 115 V	45136.1	
Stator screws (2)	45137	

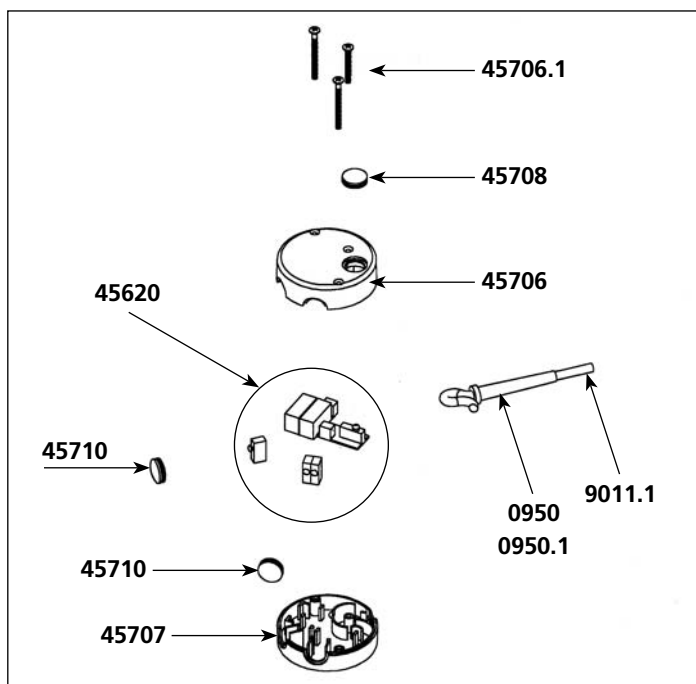
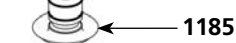
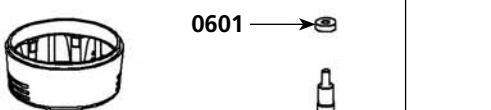
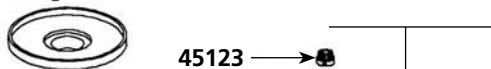
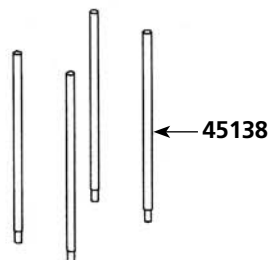
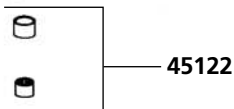
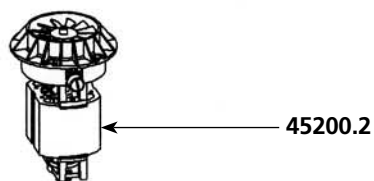
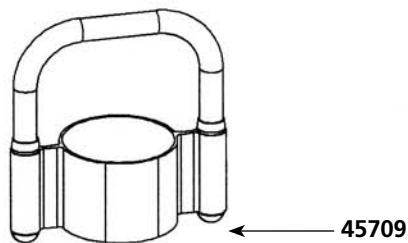
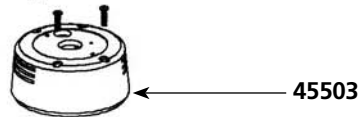
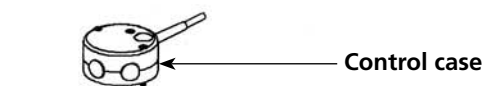

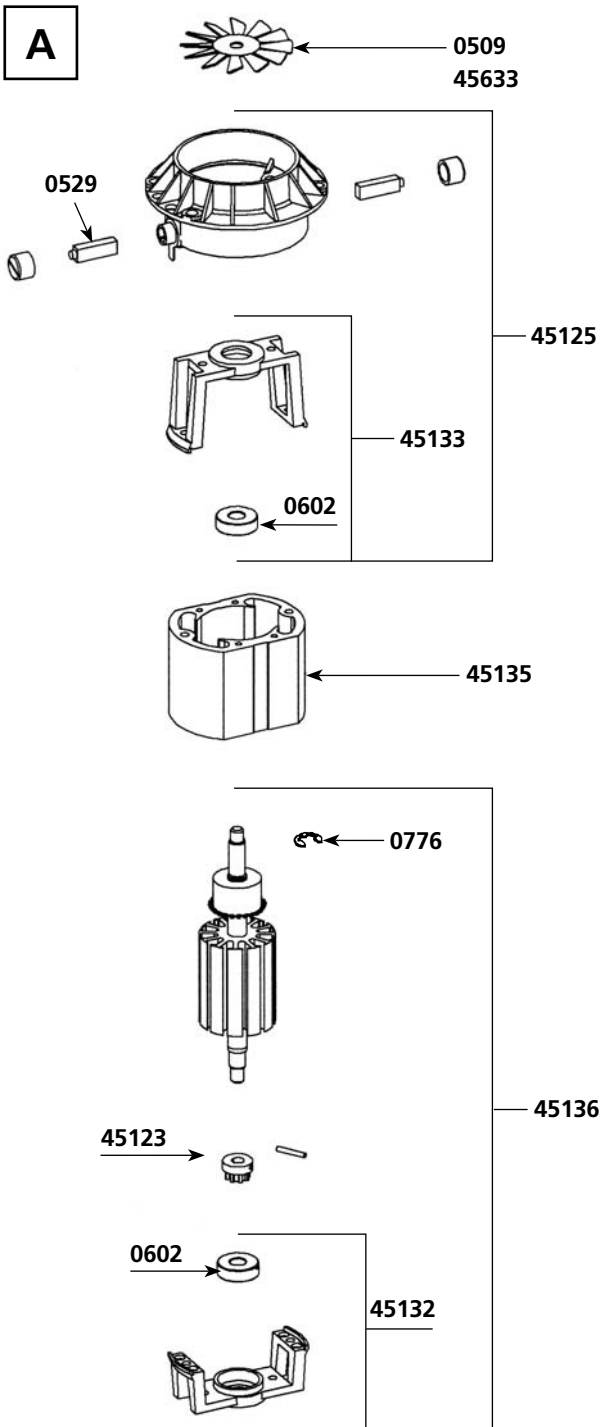

Parts list

Code

Parts list	Code	
Braces (4)	45138	
Brace screws (4)	45139	
Cutter blade w/ screw	45161	
Motor 115 V	45200.1	
Motor 230 V	45200.2	
Squeezing washers (4)	45230	
Top housing	45503	
Kit w/ shaft, lower bearing, coupler, cutter	45533	
Handle cap (2)	45610	
Circuit board	45620	
Circuit board	45620.1	
Plastic Fan	45633	
Top housing (orange plastic piece)	45706	
Screws control case set	45706.1	
Lower housing (orange plastic piece)	45707	
Handle cap protector (unit)	45708	
Sleeve & complete handle & label & cap	45709	
Handle cap protectors (unit)	45710	
Lower housing w/ screws	45711	
Foot assembly w/ lower bearing	45720	
Complete foot assembly	45722	
Power cord 230 V	9011.1	
Power cord 115 V	9040.1	
Power cord (Australian)	9066.1	
Power cord (English)	9067.1	
Bearing support screws (3)	9902	

